

# VON DUPRIN®

## Exit devices

# 33A/35A Series

## Overview

The 33A/35A Series is a narrow stile push pad device popular for its vast application coverage. With many field configurable and upgradeable solutions available, it's easy to enhance the functionality of an existing device. Mechanical and electronic options include quiet electric latch retraction, delayed and controlled egress, concealed vertical cables and security indicators. It's one way Von Duprin® protects its customers' investments long into the future.

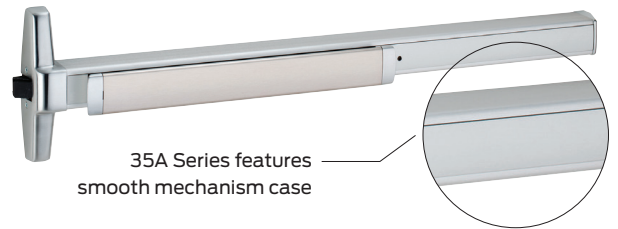
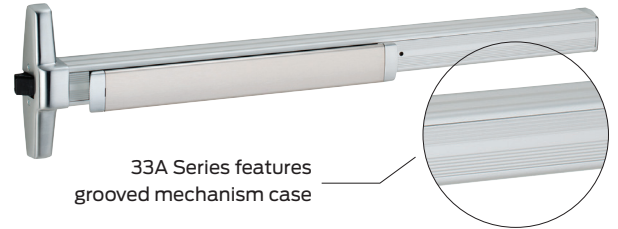

## Device types



Rim device



27A Surface mounted vertical rod device<sup>1</sup>



47A Concealed vertical rod device, 5/8" throw<sup>1</sup>

48A Concealed vertical rod device, 5/8" top, 1 1/2" bottom throw

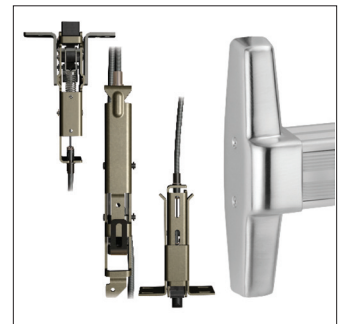

49A Concealed vertical cable device<sup>2</sup>



50AWDC Concealed vertical cable wood door device

<sup>1</sup> Also available less bottom rod (LBR)

<sup>2</sup> Also available less bottom latch (LBL)

## Finishes



**605**  
Bright Brass



**606**  
Satin Brass



**612**  
Satin Bronze

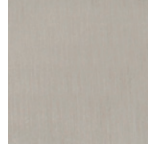

**619**  
Satin Nickel



**622**  
Matte Black



**625**  
Bright Chrome



**626**  
Satin Chrome



**626AM**  
Satin Chrome,  
Antimicrobial



**628**  
Aluminum, Clear  
Anodized



**630**  
Satin Stainless



**630AM**  
Satin Stainless,  
Antimicrobial

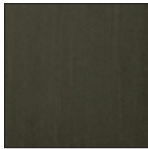

**643e**  
Aged Bronze



**693**  
Black



**710**  
Dark Brown,  
Anodized

Due to the many variations in monitors and printers, color samples may appear different than the physical product. Contact your local sales representative for a physical color sample.

## Trim functions

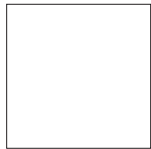

**EO No outside trim**

- Exit only



**DT Dummy trim**

- Pull when dogged (not recommended for fire device)



**NL Night latch**

- Key retracts latchbolt
- Rim cylinder

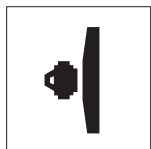

**NLOP Night latch**

- Key retracts latchbolt, optional pull required



**L Lever**

- Key locks and unlocks
- 1 1/4" mortise cylinder
- Handed, reversible lever
- Electrified lever operation available

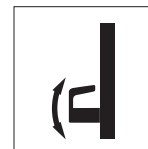

**LBE Lever, blank escutcheon**

- Always operable (no cylinder)

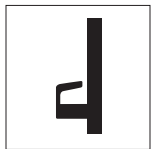

**LDT Lever, dummy trim**

- Pull when dogged

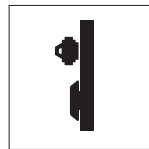

**T Thumbturn**

- Key locks and unlocks
- 1 1/4" mortise cylinder

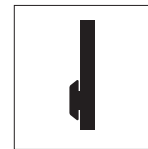

**TBE Thumbturn, blank escutcheon**

- Blank escutcheon always operable (no cylinder)

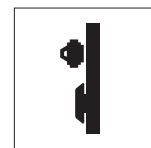

**TL Turn lever**

- Key locks and unlocks (use with DT trim)
- 1 1/4" mortise cylinder

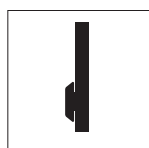

**TLBE Turn lever, blank escutcheon**

- Blank escutcheon always operable (no cylinder, use with DT trim)

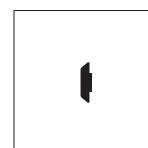

**TLOP Turn lever, optional pull**

## Trim styles



386



388



360L



360T



374T x 386DT



374T/376T x 8190 10"



388 x 550DT



360T x 550DT



388 x 8190 10"



360T x 8190 10"



392-6

## Trim styles

### Dimensions

| Trim style | Base width                        | Base height   | Projection                        | Grip width                       | Grip height                     |
|------------|-----------------------------------|---|-----------------------------------|----------------------------------|---------------------------------|
| 386/ 386DT | 1 <sup>5</sup> / <sub>8</sub> "   | 7 <sup>15</sup> / <sub>32</sub> "                           | 2 <sup>7</sup> / <sub>16</sub> "  | 4 <sup>5</sup> / <sub>16</sub> " | 8 <sup>1</sup> / <sub>2</sub> " |
| 388        | 1 <sup>11</sup> / <sub>16</sub> " | 7 <sup>15</sup> / <sub>32</sub> "                           | 1"                                |                                  |                                 |
| 360L       | 1 <sup>11</sup> / <sub>16</sub> " | 7 <sup>1</sup> / <sub>2</sub> "                             | 3"                                |                                  |                                 |
| 360T       | 1 <sup>11</sup> / <sub>16</sub> " | 7 <sup>1</sup> / <sub>2</sub> "                             | 1 <sup>13</sup> / <sub>16</sub> " |                                  |                                 |
| 374T       | 1 <sup>11</sup> / <sub>16</sub> " | 7 <sup>1</sup> / <sub>2</sub> "                             |                                   |                                  |                                 |
| 376T       | 1 <sup>11</sup> / <sub>16</sub> " | 7 <sup>1</sup> / <sub>2</sub> "                             | 1 <sup>13</sup> / <sub>16</sub> " |                                  |                                 |
| 550DT      | 3 <sup>5</sup> / <sub>8</sub> "   | 11 <sup>9</sup> / <sub>16</sub> "<br>(10" center to center) | 1 <sup>7</sup> / <sub>8</sub> "   |                                  |                                 |
| 8190 10"   | 3 <sup>1</sup> / <sub>4</sub> "   | 11"   | 3 <sup>1</sup> / <sub>4</sub> "   |                                  |                                 |
| 392-6      | 3 <sup>1</sup> / <sub>2</sub> "   | 7"<br>(6 <sup>1</sup> / <sub>4</sub> " center to center)    | 2 <sup>1</sup> / <sub>4</sub> "   |                                  |                                 |

## Lever styles

### Decorative levers



**M51**  
▪ Knurling available

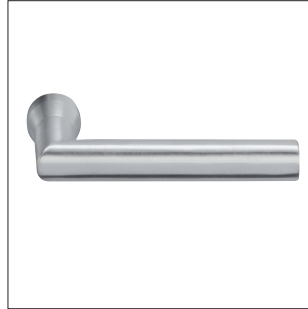

**M52**  
▪ Knurling available



**M53**



**M54**



**M55**



**M56**



**M57<sup>1</sup>**



**M61**  
▪ Handed



**M62<sup>1</sup>**  
▪ Handed

### Dimensions

| Lever | Width | Projection |
|-------|-------|------------|
| M51   | 4.5"  | 2.5"       |
| M52   | 4.5"  | 2.4"       |
| M53   | 4.4"  | 2.4"       |
| M54   | 4.4"  | 2.3"       |
| M55   | 4.4"  | 2.7"       |
| M56   | 4.5"  | 2.3"       |
| M57   | 4.5"  | 2.7"       |
| M61   | 4.5"  | 2.7"       |
| M62   | 4.6"  | 2.4"       |

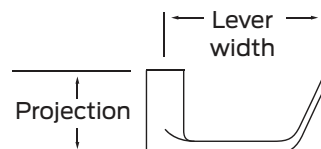

<sup>1</sup> Available in stainless steel substrate only

## Lever styles

### Decorative levers



**M63**  
▪ Handed



**M81**  
▪ Knurling available



**M82**



**M83**



**M84**



**M85**  
▪ Handed



**ME1**  
▪ Handed



**ME2**  
▪ Handed



**ME3**

### Dimensions

| Lever | Width | Projection |
|-------|-------|------------|
| M63   | 4.6"  | 2.6"       |
| M81   | 4.8"  | 2.5"       |
| M82   | 4.9"  | 2.5"       |
| M83   | 4.7"  | 2.25"      |
| M84   | 5.1"  | 2.2"       |
| M85   | 4.9"  | 2.7"       |
| ME1   | 5.4"  | 2.6"       |
| ME2   | 5.2"  | 2.4"       |
| ME3   | 5"    | 2.8"       |

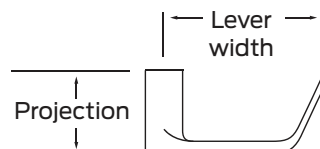

<sup>1</sup> Designed with Gensler as product design consultant

## Lever styles

### Standard levers



01



02

- Knurling available

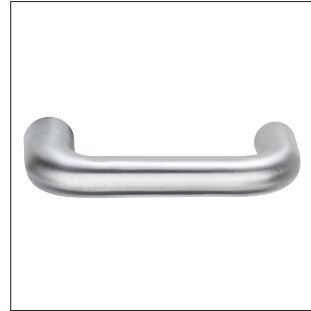

03

- Knurling available



05



06

- Default lever
- Suites with Schlage Rhodes
- Knurling available



07

- Suites with Schlage Athens



12

- Handed



16

- Suites with Schlage Omega

### Dimensions

| Lever | Width | Projection |
|-------|-------|------------|
| 01    | 4.0"  | 2.1"       |
| 02    | 4.75" | 2.3"       |
| 03    | 4.75" | 2.813"     |
| 05    | 3.75" | 2.8"       |
| 06    | 4.7"  | 2.1"       |
| 07    | 4.6"  | 2.3"       |
| 12    | 4.3"  | 2.9"       |
| 16    | 5.05" | 2.66"      |

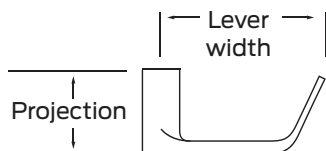



## Lever styles

### Standard levers



**17**

- Suites with Schlage Sparta
- Knurling available



**18**



**Accent (ACC)**

- Handed



**Asti (AST)**

- Handed



**Merano (MER)**

- Handed

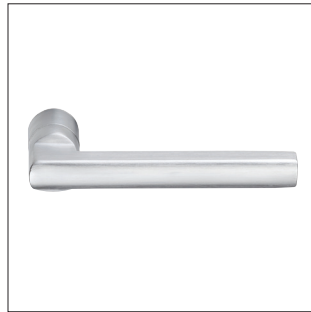

**Latitude (LAT)**



**Longitude (LON)**

### Dimensions

| Lever           | Width | Projection |
|-----------------|-------|------------|
| 17              | 4.7"  | 2.3"       |
| 18              | 4.75" | 2.4"       |
| Accent (ACC)    | 4.4"  | 3.1"       |
| Asti (AST)      | 4.2"  | 2.5"       |
| Merano (MER)    | 4.1"  | 2.5"       |
| Latitude (LAT)  | 4.6"  | 2.3"       |
| Longitude (LON) | 4.9"  | 2.3"       |

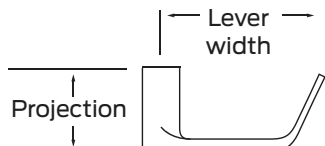

## Electromechanical device options

### Switches

- LX**            **Latchbolt monitoring**  
**LX-LC**        **Latchbolt monitoring, low current**
- Signals use of an opening
  - SPDT switch to monitor latch bolt
  - 2 A maximum @ 24VDC; below 50 mA @ 24VDC for low current option
- RX**            **Request to exit**  
**RX-LC**        **Request to exit - low current**  
**RX-2**         **Double request to exit - 2 RX switches**  
**WP-RX**       **Waterproof request to exit**
- Signals use of an opening
  - SPDT switch to monitor pushpad
  - 2 A maximum @ 24VDC; below 50 mA @ 24VDC for low current option
- LX-RX**        **Request to exit/latchbolt monitoring combination**  
**LX-RX-LC**   **Request to exit/latchbolt monitoring combination, low current**
- 2 A maximum @ 24VDC; below 50 mA @ 24VDC for low current option
- SS**            **Signal switch**
- Monitors pushpad and latchbolt
  - Signals unauthorized use of an opening
  - Switch makes latch bolt tamper-resistant
  - Up to 2.0 A @ 24VDC

### Latch retraction

- EL**            **Electric latch retraction**
- Enables remote unlatching
  - Alternative to manual dogging
  - Voltage: 24VDC (continuous duty)
  - Current: 16.0 A inrush / 0.3 A holding
- QEL**         **Quiet electric latch retraction**  
**HD-QEL**      **Quiet electric latch retraction with hex dogging**
- Bolt retraction via switch
  - Converts exit door to push-pull operation
  - Voltage: 24VDC
  - Current: 1.0 A inrush (0.5 sec.) / 0.14 A holding

### Delayed egress

- CX**            **Chexit delayed exit**
- Meets NFPA 101 requirements
  - Self-contained controls, locking, alarm
  - Input voltage: 24VDC
  - Input current inrush: 1.25 A
  - Input current holding: 390 mA
  - Alarm relay and secure relay contact ratings: 24 VDC, 1 A
- CX-RCM**     **Chexit remote module**
- Chexit for smaller doors that can not accommodate a standard Chexit device
  - Size: 3.75" x 5.57" x 2.50"
  - Input voltage: 24VDC
  - Input current inrush: 1.25A
  - Input current holding: 390mA
  - Alarm relay and secure relay contact ratings: 24 VDC, 1 A

### Miscellaneous

- ALK**         **Alarm exit kit**
- Unauthorized opening triggers 85-decibel horn
  - Set in armed or disarmed mode by key
  - Assembly includes both a 24VDC input and external inhibit
- CON**         **Allegion Connect**
- Common connectors to connect various door hardware all the way to the power supply
- E360**        **Electric locking and unlocking trim**
- Remains latched while unlocked
  - Remote electrical control
  - Voltage: 24VDC (Continuous Duty)
  - Current: 0.22 amps

## Electromechanical device options

Matrix shows available options per device type but does not represent compatibility across multiple options.

|                          | Switches       |       |    |       |      |       |       |          |    | Latch retraction |     |        | Delayed egress |        | Misc |     |      |
|--------------------------|----------------|-------|----|-------|------|-------|-------|----------|----|------------------|-----|--------|----------------|--------|------|-----|------|
|                          | LX             | LX-LC | RX | RX-LC | RX-2 | WP-RX | LX-RX | LX-RX-LC | SS | EL               | QEL | HD-QEL | CX             | CX-RCM | ALK  | CON | E360 |
| 33A<br>35A               | ▪              | ▪     | ▪  | ▪     | ▪    | ▪     | ▪     | ▪        | ▪  | ▪                | ▪   | ▪      | ▪              | ▪      | ▪    | ▪   | ▪    |
| 33A-F<br>35A-F           | ▪              | ▪     | ▪  | ▪     | ▪    | ▪     | ▪     | ▪        | ▪  | ▪                | ▪   | ▪      | ▪              | ▪      | ▪    | ▪   | ▪    |
| 3327A<br>3527A           | ▪              | ▪     | ▪  | ▪     | ▪    | ▪     | ▪     | ▪        | ▪  | ▪                | ▪   | ▪      | ▪              | ▪      | ▪    | ▪   | ▪    |
| 3327A-F<br>3527A-F       | ▪              | ▪     | ▪  | ▪     | ▪    | ▪     | ▪     | ▪        | ▪  | ▪                | ▪   | ▪      | ▪              | ▪      | ▪    | ▪   | ▪    |
| 3347A<br>3547A           | ▪              | ▪     | ▪  | ▪     | ▪    | ▪     | ▪     | ▪        | ▪  | ▪                | ▪   | ▪      | ▪              | ▪      | ▪    | ▪   | ▪    |
| 3347A-F<br>3547A-F       | ▪              | ▪     | ▪  | ▪     | ▪    | ▪     | ▪     | ▪        | ▪  | ▪                | ▪   | ▪      | ▪              | ▪      | ▪    | ▪   | ▪    |
| 3348A<br>3548A           | ▪              | ▪     | ▪  | ▪     | ▪    | ▪     | ▪     | ▪        | ▪  | ▪                | ▪   | ▪      | ▪              | ▪      | ▪    | ▪   | ▪    |
| 3348A-F<br>3548A-F       | ▪              | ▪     | ▪  | ▪     | ▪    | ▪     | ▪     | ▪        | ▪  | ▪                | ▪   | ▪      | ▪              | ▪      | ▪    | ▪   | ▪    |
| 3349A<br>3549A           | ▪ <sup>1</sup> | ▪     | ▪  | ▪     | ▪    | ▪     | ▪     | ▪        | ▪  | ▪                | ▪   | ▪      | ▪              | ▪      | ▪    | ▪   | ▪    |
| 3349A-F<br>3549A-F       | ▪ <sup>1</sup> | ▪     | ▪  | ▪     | ▪    | ▪     | ▪     | ▪        | ▪  | ▪                | ▪   | ▪      | ▪              | ▪      | ▪    | ▪   | ▪    |
| 3350AWDC<br>3550AWDC     | ▪              | ▪     | ▪  | ▪     | ▪    | ▪     | ▪     | ▪        | ▪  | ▪                | ▪   | ▪      | ▪              | ▪      | ▪    | ▪   | ▪    |
| 3350AWDC-F<br>3550AWDC-F | ▪              | ▪     | ▪  | ▪     | ▪    | ▪     | ▪     | ▪        | ▪  | ▪                | ▪   | ▪      | ▪              | ▪      | ▪    | ▪   | ▪    |

<sup>1</sup> For 3349A/3549A devices, LX switch monitors trim input or electric dogging of EL/QEL devices. LX switch does not monitor latchbolt condition.

## Mechanical device options

### Dogging

---

- CD**      **Cylinder dogging, panic only**
- LD**      **Less dogging**
- CDSI**     **Cylinder dogging with indicator**
- Provides visible lock/unlock indicators showing whether device is dogged or undogged
- HDSI**     **Hex dogging with indicator**
- Provides visible lock/unlock indicators showing whether device is dogged or undogged

### Environmental

---

- PN**      **Pneumatic latch retraction**
- For areas where electrical devices banned
  - Special linkage for mechanical or pneumatic dogging
- QM**      **Quiet mechanical option**
- Provides damper-controlled relatching of device
- INS**     **Insulclad kits**
- Kits with longer fasteners or parts for Insulclad doors
- AM**      **Anti-microbial finish**

### Weatherized

---

- WH**      **Weep holes**
- Drainage (weep) holes in mechanism case

### California code

---

- AX**      **Accessible device**
- UL certified to meet new 5 lb. maximum operating force requirement
  - Exceeds ANSI/BHMA requirements

### Latches

---

- PL**      **Pullman latch**
- Latches are always extended
  - Most commonly used in conjunction with electric strikes and LBR-less bottom rod application

### Touch bar trim

---

- RSS**     **Red silk screen**
- Red silk-screened lettered touchbar trim
- PUSH**   **PUSH**
- Touchbar trim embossed PUSH
- SG**      **Safety glow**
- Self-illuminating touchpad
  - Glows brightly during low or no light conditions
- KN**      **Knurled touchbar**
- Tactile warning applied to device
- BRAILLE** **Braille**
- Vision impaired touchpad
  - Raised letter and Braille

## Mechanical device options

Matrix shows available options per device type but does not represent compatibility across multiple options.

|                            | Dogging |    |      |      | Environmental |    |     |    | Weatherized | CA code | Latches | Touch bar trim |      |    |    |         |
|----------------------------|---------|----|------|------|---------------|----|-----|----|-------------|---------|---------|----------------|------|----|----|---------|
|                            | CD      | LD | CDSI | HDSI | PN            | QM | INS | AM | WH          | AX      | PL      | RSS            | PUSH | SG | KN | BRAILLE |
| 35A<br>33A                 | ▪       | ▪  | ▪    | ▪    | ▪             | ▪  |     | ▪  | ▪           | ▪       |         | ▪              | ▪    | ▪  | ▪  | ▪       |
| 35A-F<br>33A-F             |         |    |      |      | ▪             | ▪  |     | ▪  | ▪           | ▪       |         | ▪              | ▪    | ▪  | ▪  | ▪       |
| 3527A<br>3327A             | ▪       | ▪  | ▪    | ▪    | ▪             | ▪  |     | ▪  | ▪           |         | ▪       | ▪              | ▪    | ▪  | ▪  | ▪       |
| 3527A-F<br>3327A-F         |         |    |      |      | ▪             | ▪  |     | ▪  | ▪           |         |         | ▪              | ▪    | ▪  | ▪  | ▪       |
| 3547A<br>3347A             | ▪       | ▪  | ▪    | ▪    | ▪             |    | ▪   | ▪  | ▪           |         | ▪       | ▪              | ▪    | ▪  | ▪  | ▪       |
| 3547A-F<br>3347A-F         |         |    |      |      | ▪             |    |     | ▪  | ▪           |         |         | ▪              | ▪    | ▪  | ▪  | ▪       |
| 3548A<br>3348A             | ▪       | ▪  | ▪    | ▪    | ▪             |    |     | ▪  | ▪           |         |         | ▪              | ▪    | ▪  | ▪  | ▪       |
| 3548A-F<br>3348A-F         |         |    |      |      | ▪             |    |     | ▪  | ▪           |         |         | ▪              | ▪    | ▪  | ▪  | ▪       |
| 3549A<br>3349A             | ▪       | ▪  | ▪    | ▪    | ▪             |    | ▪   | ▪  | ▪           | ▪       |         | ▪              | ▪    | ▪  | ▪  | ▪       |
| 3549A-F<br>3349A-F         |         |    |      |      | ▪             |    |     | ▪  | ▪           | ▪       |         | ▪              | ▪    | ▪  | ▪  | ▪       |
| 3550A-WDC<br>3350A-WDC     | ▪       | ▪  | ▪    | ▪    | ▪             |    |     | ▪  | ▪           |         |         | ▪              | ▪    | ▪  | ▪  | ▪       |
| 3550A-WDC-F<br>3350A-WDC-F |         |    |      |      | ▪             |    |     | ▪  | ▪           |         |         | ▪              | ▪    | ▪  | ▪  | ▪       |

## Specifications

|                           |  |
|---------------------------|--|
| Accessibility             | <ul style="list-style-type: none"> <li>■ Force to depress push pad                             <ul style="list-style-type: none"> <li>- AX device: 5 lbs</li> <li>- Standard device: 15 lbs</li> </ul> </li> <li>■ Push pad projection                             <ul style="list-style-type: none"> <li>- Neutral: 3 <sup>13</sup>/<sub>16</sub>" (97 mm)</li> <li>- Depressed: 3 <sup>1</sup>/<sub>16</sub>" (78 mm)</li> </ul> </li> </ul> |
| Certifications/ approvals | All Von Duprin 33A and 35A exit devices are ANSI/BHMA Certified. Please refer to the BHMA Certified Products Directory for specific listings.  |
| Mounting height           | 39 <sup>13</sup> / <sub>16</sub> " (1011 mm)<br>39 <sup>11</sup> / <sub>16</sub> " (1008 mm) with mullion  |
| Warranty                  | 36 months from the date of placing the product in operation  |

## Dimensions

